

MO AC series

Medium & High Level Order Picker

1,000kg

- Yale AC technology
- AC motors
- CANbus
- Fly-by-wire steering
- Enhanced comfort and performance
- Low maintenance features



Truck Dimensions

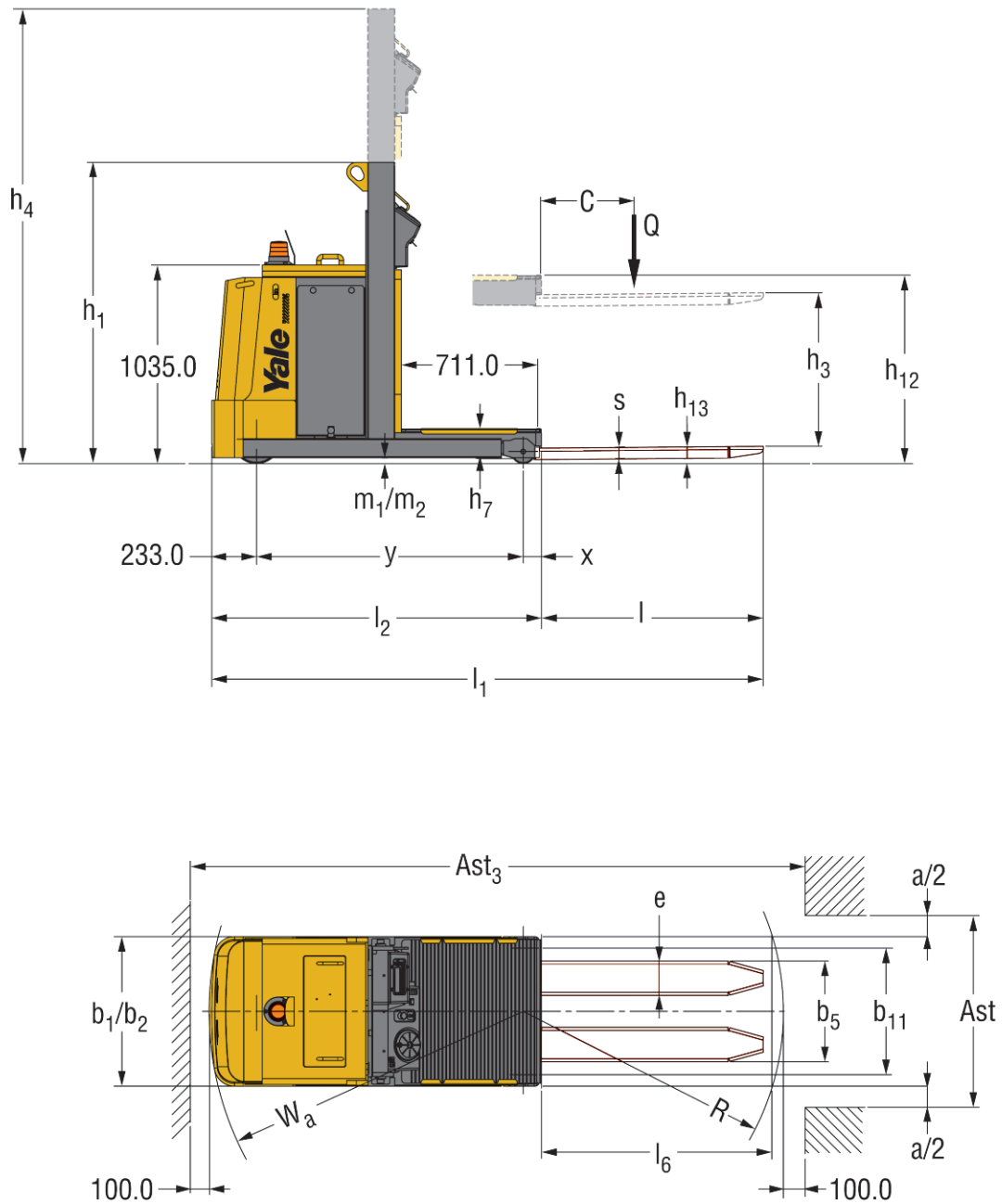

Mast details - MO10E AC

Model	Overall extended height (h^1)	Platform height from floor (h^{12})	Overall lowered height (h^1)
	mm	mm	mm
MO10E AC - 32	5298	3207	2275
MO10E AC - 36	5698	3607	2475
MO10E AC - 40	6098	4007	2675
MO10E AC - 44	6498	4407	2875
MO10E AC - 48	6898	4807	3075

VDI 2198 - General Specifications - MO10E AC 0.7, 12, 15

Distinguishing mark	1.1	Manufacturer (abbreviation)		Yale	Yale	Yale
	1.2	Manufacturer's type designation		MO10E AC 0.7 FC	MO10E AC 15 FC	MO10E AC 12
	1.3	Drive: electric (battery or mains), diesel, petrol, fuel gas		Battery	Battery	Battery
	1.4	Operator type: hand, pedestrian, standing, seated, order-picker		Order-picker	Order-picker	Order-picker
	1.5	Rated capacity/rated load	Q (kg)	1000	1000	1000
	1.6	Load centre distance	c (mm)	600	600	600
	1.8	Load distance, centre of drive axle to fork	x (mm)	144	144	96
	1.9	Wheelbase	y (mm)	1390	1390	1390
	Weights	2.1	Service weight	kg	1550	1750
2.2		Axle loading, laden front/rear	kg	350 / 2200	350 / 2400	350 / 2250
2.3		Axle loading, unladen front/rear	kg	900 / 650	950 / 800	900 / 700
Tyres/chassis	3.1	Tyres: solid rubber, superelastic, pneumatic, polyurethane		Vulkollan / Topthane	Vulkollan / Topthane	Vulkollan / Topthane
	3.2	Tyre size, front		ø 254 x 125	ø 254 x 125	ø 254 x 125
	3.3	Tyre size, rear		ø 125 x 94	ø 125 x 94	ø 125 x 94
	3.5	Wheels, number front/rear (x = driven wheels)		1 x /2	1 x /2	1 x /2
	3.6	Tread, front	b10 (mm)	-	-	-
	3.7	Tread, rear	b11 (mm)	660	660	660
	Dimensions	4.2	Height of mast, lowered	h1 (mm)	1957	1957
4.3		Free lift	h2 (mm)	-	-	-
4.4		Lift	h3 (mm)	690	1410	1010
4.5		Height, mast extended	h4 (mm)	-	-	2590
4.7		Height of overhead guard (cabin)	h6 (mm)	-	-	-
4.8		Seat height/stand height	h7 (mm)	180	180	180
4.11		Additional lift	h9 (mm)	-	-	-
4.14		Stand height, elevated	h12 (mm)	-	-	1190
4.15		Height, lowered	h13 (mm)	90	90	90
4.19		Overall length ^(N)	l1 (mm)	2907	2907	2874
4.20		Length to face of forks ^(N)	l2 (mm)	1767	1767	1719
4.21		Overall width	b1/b2 (mm)	796	796	780
4.22		Fork dimensions ISO 2331	s/e/l (mm)	60 / 180 / 1140	60 / 180 / 1140	60 / 180 / 1155
4.23		Fork carriage ISO 2328, class/type A, B		-	-	-
4.24		Fork carriage width	b3 (mm)	700	700	-
4.25		Distance between fork-arms	b5 (mm)	560	560	526
4.27		Width across guide rolls ^(O)	b6 (mm)	-	-	-
4.31		Ground clearance, laden, below mast	m1 (mm)	30	30	30
4.32	Ground clearance, centre of wheelbase	m2 (mm)	30	30	30	
4.33	Load dimensions b12 x l6 crossways	b12 x l6 (mm)	1400	1400	1400	
4.34.1	Aisle width for pallets 1000 x 1200 crossways	Ast (mm)	1000	1000	1000	
4.34.2	Aisle width for pallets 800 x 1200 lengthways ^(N)	Ast (mm)	1640	1640	1640	
4.35	Turning radius	Wa (mm)	3270	3270	3200	
Performance data	5.1	Travel speed, laden/unladen ^(J)	km/h	10.1 / 10.4	10.1 / 10.4	10.1 / 10.4
	5.2.1	Lift speed, laden/unladen (Cab) ^(J)	km/h	-	-	0.17 / 0.25
	5.2.2	Lift speed, laden/unladen (SL) ^(J)	m/s	0.09 / 0,18	0.09 / 0.18	-
	5.3.1	Lowering speed, laden/unladen (Cab) ^(J)	m/s	-	-	0.29 / 0.25
	5.3.2	Lowering speed, laden/unladen (SL) ^(J)	m/s	0.20 / 0.07	0.20 / 0.07	-
	5.7	Gradeability, laden/unladen	m/s	5 / 8	5 / 8	5 / 8
	5.10	Service brake	%	Electro Magnetic	Electro Magnetic	Electro Magnetic
Electric-engine	6.1	Drive motor rating S2 60 min		4	4	4
	6.2	Lift motor rating at S3 15%	kW	3	3	3
	6.3	Battery according to DIN 43531/35/36 A, B, C, no	kW	DIN 43535 B	DIN 43535 B	DIN 43535 B
	6.4	Battery voltage/nominal capacity K5	(V) / (Ah)	24 / 560	24 / 560	24 / 560
	6.5	Battery weight	kg	480	480	480
	6.6	Energy consumption according to VDI cycle	kWh/h @ no. of cycles	2.28	2.35	2.30
Addition data	8.1	Type of drive unit		AC ~ MOSFET	AC ~ MOSFET	AC ~ MOSFET
	10.7	Sound pressure level at the driver's seat	dB (A)	< 70	< 70	< 70

(H) All models: See VDI table or refer to your local sales representative for Ast values not listed.

(I) Values determined by wheel friction, if climbing ramps frequently (within 1h), consult your sales representative.

(J) Performance Mode: 3 preset values available, selected by the operator: soft, medium, hard.

All values listed are in Hard mode.

(N) With wire guidance l1 and l2 + 40mm.

(O) Minimum size is shown, for other size contact the dealer.

Truck Dimensions MO10E AC WP, MO10E AC SL

MO10E AC WP

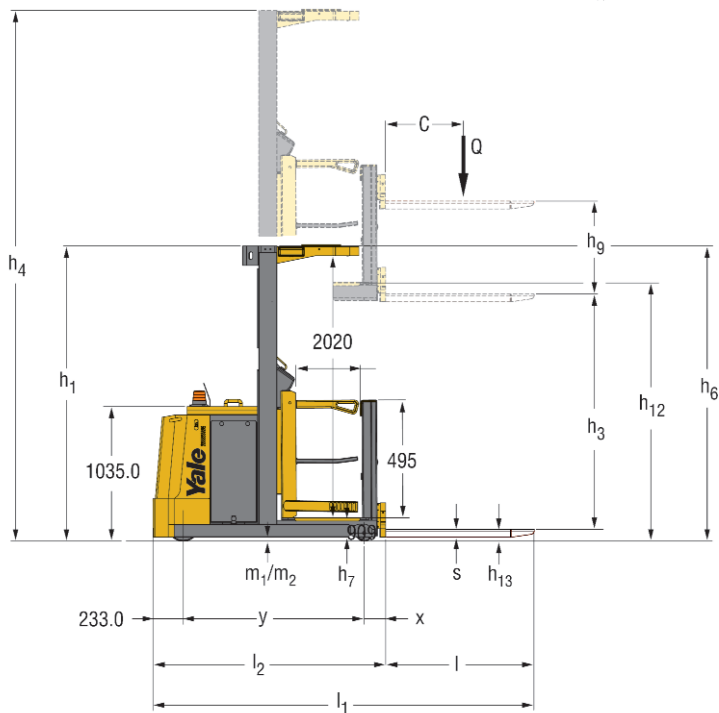
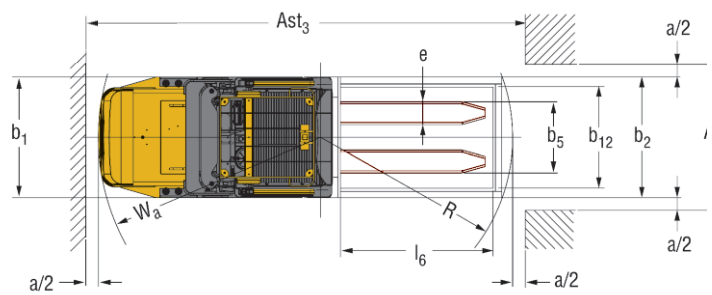
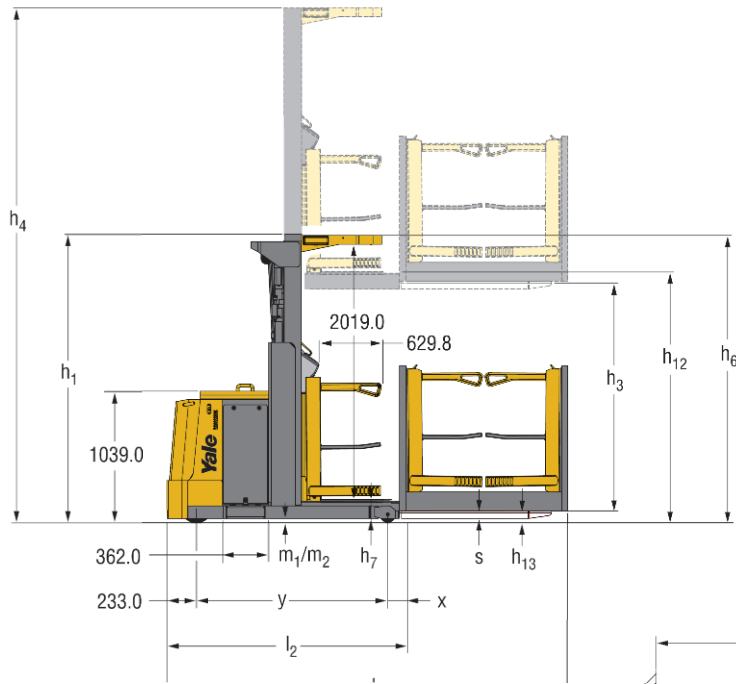

MO10E AC SL

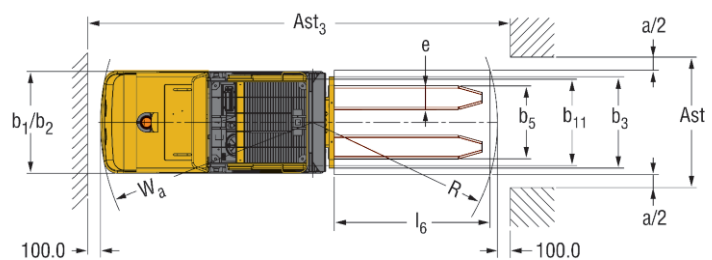

VDI 2198 - General Specifications - MO10E AC 12SL, 17SL, 48SL, 17WP, 48WP

Distinguishing mark	1.1	Manufacturer (abbreviation)		Yale	Yale	Yale	Yale	Yale
	1.2	Manufacturer's type designation		MO10E AC 12 SL	MO10E AC 17 SL	MO10E AC 17 WP	MO10E AC 48 SL ^(L)	MO10E AC 48 WP ^(L)
	1.3	Drive: electric (battery or mains), diesel, petrol, fuel gas		Battery	Battery	Battery	Battery	Battery
	1.4	Operator type: hand, pedestrian, standing, seated, order-picker		Order-picker	Order-picker	Order-picker	Order-picker	Order-picker
	1.5	Rated capacity/rated load	Q (kg)	1000	1000	1000	1000	1000
	1.6	Load centre distance	c (mm)	600	600	600	600	600
	1.8	Load distance, centre of drive axle to fork ^(A)	x (mm)	166	166	166	157	166
	1.9	Wheelbase	y (mm)	1390	1390	1390	1510	1510
	Weights	2.1	Service weight	kg	1700	1800	2000	2665
2.2		Axle loading, laden front/rear	kg	350 / 2350	350 / 2450	350 / 2650	2645 / 1020	2645 / 1220
2.3		Axle loading, unladen front/rear	kg	980 / 750	950 / 850	950 / 1050	1120 / 1555	1120 / 1755
Tyres/chassis	3.1	Tyres: solid rubber, superelastic, pneumatic, polyurethane		Vulkollan / Topthane	Vulkollan / Topthane	Vulkollan / Topthane	Vulkollan / Topthane	Vulkollan / Topthane
	3.2	Tyre size, front		ø 254 x 125	ø 254 x 125	ø 254 x 125	ø 254 x 125	ø 254 x 125
	3.3	Tyre size, rear		ø 125 x 94	ø 125 x 94	ø 125 x 94	ø 125 x 94	ø 125 x 94
	3.5	Wheels, number front/rear (x = driven wheels)		1 x /2	1 x /2	1 x /2	1 x /2	1 x /2
	3.6	Tread, front	b10 (mm)	-	-	-	-	-
	3.7	Tread, rear	b11 (mm)	660	660	660	830	830
	Dimensions	4.2	Height of mast, lowered	h1 (mm)	1654	2270	2270	3075
4.3		Free lift	h2 (mm)	-	-	-	-	-
4.4		Lift	h3 (mm)	1010	1510	1510	4627	4627
4.5		Height, mast extended ^(B)	h4 (mm)	2590	3800	3800	6898	6898
4.7		Height of overhead guard (cabin) ^(B)	h6 (mm)	-	2270	2270	2270	2270
4.8		Seat height/stand height	h7 (mm)	180	180	180	180	180
4.11		Additional lift	h9 (mm)	690	690	-	690	-
4.14		Stand height, elevated	h12 (mm)	1190	1690	1690	4807	4807
4.15		Height, lowered ^(C)	h13 (mm)	90	90	80	90	90
4.19		Overall length ^(N)	l1 (mm)	2929	2907	3099	3040	3220
4.20		Length to face of forks ^{(A) (N)}	l2 (mm)	1789	1789	1789	1900	1910
4.21		Overall width ^(O)	b1/b2 (mm)	780	780	780 / 996 ^(P)	950	950 / 996 ^(P)
4.22		Fork dimensions ISO 2331 ^(E)	s/e/l (mm)	60 / 180 / 1140	60 / 180 / 1140	60 / 180 / 1140	60 / 180 / 1140	60 / 180 / 1140
4.23		Fork carriage ISO 2328, class/type A, B		-	-	-	-	-
4.24		Fork carriage width ^(F)	b3 (mm)	700	700	-	700	-
4.25		Distance between fork-arms ^(G)	b5 (mm)	560	560	560	560	560
4.27		Width across guide rolls ^(G)	b6 (mm)	-	-	-	1090	1090
4.31		Ground clearance, laden, below mast	m1 (mm)	30	30	30	30	30
4.32		Ground clearance, centre of wheelbase	m2 (mm)	30	30	30	30	30
4.33		Load dimensions b12 x l6 crossways	b12 x l6 (mm)	1400	1400	-	1400	-
4.34.1	Aisle width for pallets 1000 x 1200 crossways	Ast (mm)	1000	1000	1196	1150	1196	
4.34.2	Aisle width for pallets 800 x 1200 lengthways ^(H)	Ast (mm)	1640	1640	1640	1760	1760	
4.35	Turning radius	Wa (mm)	3270	3270	3400	3390	3520	
Performance data	5.1	Travel speed, laden/unladen ^(I)	km/h	10.1 / 10.4	10.1 / 10.4	10.1 / 10.4	8.6 / 9.5	8.6 / 9.5
	5.2.1	Lift speed, laden/unladen (Cab) ^(I)	km/h	0.11 / 0.21	0.11 / 0.21	0.15 / 0.20	0.15 / 0.20	0.15 / 0.20
	5.2.2	Lift speed, laden/unladen (SL) ^(I)	m/s	0.09 / 0.18	0.09 / 0.18	-	0.09 / 0.18	-
	5.3.1	Lowering speed, laden/unladen (Cab) ^(I)	m/s	0.26 / 0.14	0.26 / 0.14	0.28 / 0.24	0.27 / 0.23	0.28 / 0.24
	5.3.2	Lowering speed, laden/unladen (SL) ^(I)	m/s	0.20 / 0.07	0.20 / 0.07	-	0.20 / 0.07	-
	5.7	Gradeability, laden/unladen ^(J)	m/s	5 / 8	5 / 8	5 / 8	5 / 8	5 / 8
	5.10	Service brake	%	Electro Magnetic	Electro Magnetic	Electro Magnetic	Electro Magnetic	Electro Magnetic
Electric-engine	6.1	Drive motor rating S2 60 min		4	4	4	4	4
	6.2	Lift motor rating at S3 15%	kW	3	3	3	3	3
	6.3	Battery according to DIN 43531/35/36 A, B, C, no	kW	DIN 43535 B	DIN 43535 B	DIN 43535 B	DIN 43535 B	DIN 43535 B
	6.4	Battery voltage/nominal capacity K5	(V) / (Ah)	24 / 560	24 / 560	24 / 560	24 / 560	24 / 560
	6.5	Battery weight	kg	480	480	480	480	480
	6.6	Energy consumption according to VDI cycle	kWh/h @ no. of cycles	2.38	2.40	2.40	2.86	2.90
8.1	Type of drive unit		AC ~ MOSFET	AC ~ MOSFET	AC ~ MOSFET	AC ~ MOSFET	AC ~ MOSFET	
10.7	Sound pressure level at the driver's seat	dB (A)	< 70	< 70	< 70	< 70	< 70	

MO10E SL models VDI Notes:

^(A) With FEM carriage and forks 80 x 30mm + 20mm. With FEM carriage and forks 100 x 35mm + 25mm.

^(B) **Note for models with over head guard:** With lift interrupt mounted on OHG h6+ 80mm.

^(C) With FEM carriage and forks 80 x 30mm h13= 35mm. With FEM carriage and forks 100 x 35mm h13= 40mm

^(D) With FEM carriage b2= 800mm.

^(E) Available also FEM carriage and fork size 80 x 30mm (600 Kg @ 600mm, 800 Kg @ 500mm, 1000 Kg @ 400mm) and 100 x 35mm with 1000 Kg @ 600mm.

^(F) With FEM carriage b3= 800mm.

^(G) With FEM carriage and forks 80 x 30mm b5= 753mm. With FEM carriage and forks 100 x 35mm b5= 773mm.

^(H) **All models:** See VDI table or refer to your local sales representative for Ast values not listed.

^(I) Values determined by wheel friction, if climbing ramps frequently (within 1h), consult your sales representative.

^(L) Performance Mode: 3 preset values available, selected by the operator: soft, medium, hard. All values listed are in Hard mode.

^(L) Value determined with highest mast, see chart for other h data.

^(N) With wire guidance l1 and l2 + 40mm.

^(O) Minimum size is shown, for other size contact the dealer.

^(P) b12: width WP; b2 is the same as non WP version.

Truck Dimensions MO10 AC, MO10S AC

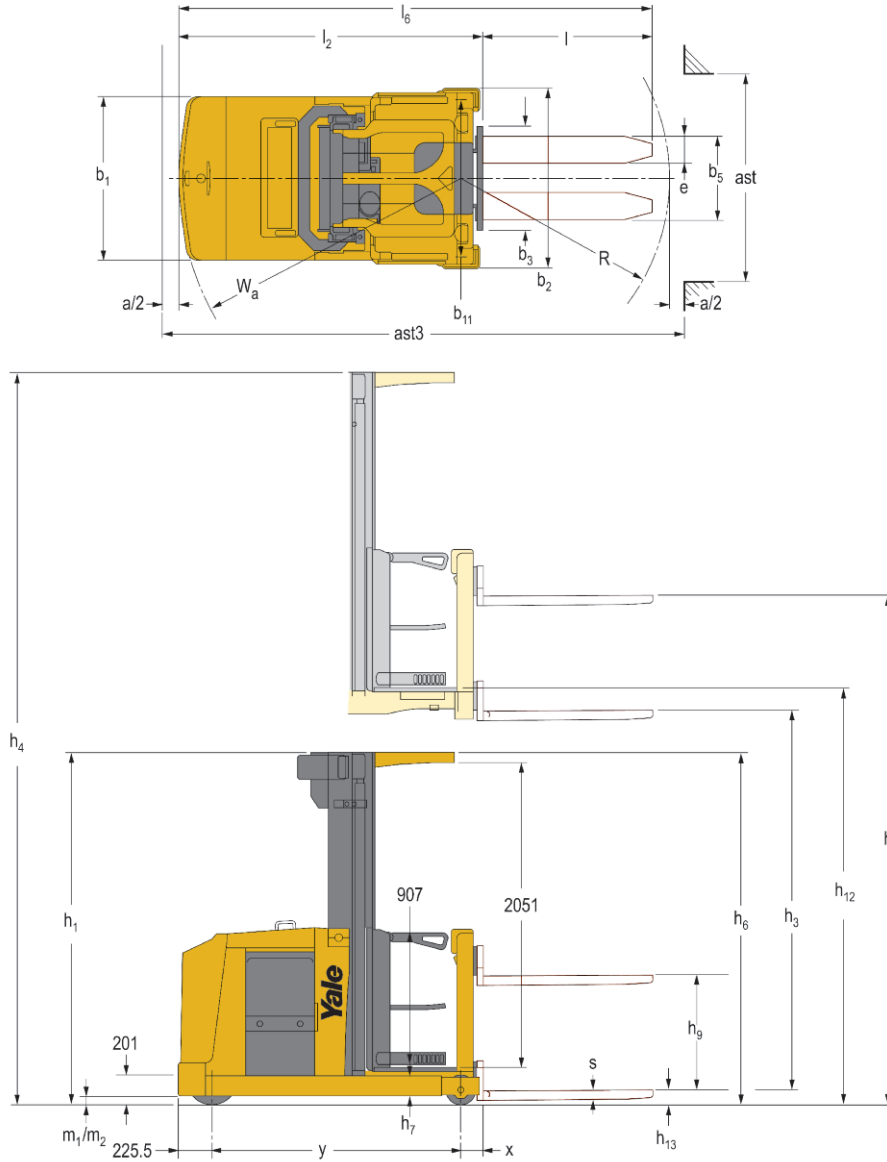

Mast Details MO10 AC, MO10S AC

Mast type	Model	Overall width (b ²) mm	Overall extended fork height (h) mm	Height of platform raised (h ¹²) mm	Auxiliary lift (h ¹) mm	Lift height (h ³) mm	Overall lowered mast height (h ¹) mm	Overall extended mast /cab height (h ¹) mm
2-stage	MO10 AC	1000	4230	3620	770	3370	2420	5740
		1000	4530	3920	770	3670	2570	6040
		1000	5130	4520	770	4270	2870	6640
2-stage	MO10S AC	1100 or 1200	4230	3620	770	3370	2420	5740
		1100 or 1200	4530	3920	770	3670	2570	6040
		1100 or 1200	5130	4520	770	4270	2870	6640
		1100 or 1200	5630	5020	770	4770	3120	7140
		1100 or 1200	6130	5520	770	5270	3370	7640
		1100 or 1200	6630	6020	770	5770	3620	8140
		1100 or 1200	7130	6520	770	6270	3870	8640
3-stage	MO10S AC	1100 or 1200	5705	5095	770	4845	2370	7215
		1100 or 1200	6005	5395	770	5145	2470	7515
		1100 or 1200	6605	5995	770	5745	2670	8115
		1100 or 1200	7205	6595	770	6345	2870	8715
		1200	7805	7195	770	6945	3070	9315
		1200	8405	7795	770	7545	3270	9915
		1200	9005	8395	770	8145	3470	10515

VDI 2198 - General Specifications - MO10E AC 12SL, 17SL, 48SL, 17WP, 48WP

Distinguishing mark	1.1	Manufacturer (abbreviation)		Yale	Yale	Yale
	1.2	Manufacturer's type designation		MO10 AC	MO 10S AC	MO 10S AC
	1.3	Drive: electric (battery or mains), diesel, petrol, fuel gas		Battery	Battery	Battery
	1.4	Operator type: hand, pedestrian, standing, seated, order-picker		Order-picker	Order Picker	Order Picker
	1.5	Rated capacity/rated load	Q (kg)	1000	1000	1000
	1.6	Load centre distance	c (mm)	600	600	600
	1.8	Load distance, centre of drive axle to fork ⁽¹⁾	x (mm)	166	150 ^(2a)	205 ^(2b)
	1.9	Wheelbase	y (mm)	1534.5	1574.5	1674.5
	Weights	2.1	Service weight	kg	2890	3255
2.2		Axle loading, laden front/rear	kg	1060 / 2830	1515 / 2760	1760 / 3305
2.3		Axle loading, unladen front/rear	kg	1240 / 1650	1940 / 1315	2200 / 1865
Tyres/chassis	3.1	Tyres: solid rubber, superelastic, pneumatic, polyurethane		Polyurethane	Polyurethane	Polyurethane
	3.2	Tyre size, front		ø 343 x 140	ø 343 x 140	ø 343 x 140
	3.3	Tyre size, rear		ø 200 x 80	ø 200 x 80	ø 200 x 100
	3.5	Wheels, number front/rear (x = driven wheels)		1 x / 2	1 x / 2	1 x / 2
	3.6	Tread, front	b10 (mm)	-	-	-
	3.7	Tread, rear	b11 (mm)	877	977	1057
	Dimensions	4.2	Height of mast, lowered	h1 (mm)	3070	3320
4.3		Free lift	h2 (mm)	-	-	-
4.4		Lift	h3 (mm)	4670	5170	8895
4.5		Height, mast extended ⁽³⁾	h4 (mm)	7040	7540	11265
4.7		Height of overhead guard (cabin) ⁽³⁾	h6 (mm)	2370	2370	2370
4.8		Seat height/stand height	h7 (mm)	250	250	250
4.11		Additional lift	h9 (mm)	770	770	770
4.14		Stand height, elevated	h12 (mm)	4920	5420	9145
4.15		Height, lowered ⁽⁴⁾	h13 (mm)	90	90	90
4.19		Overall length ^{(6) (1)}	l1 (mm)	3087	3087	3242
4.20		Length to face of forks ^{(6) (1)}	l2 (mm)	1947	1947	2102
4.21		Overall width	b1/b2 (mm)	1000 / 1000	1100/1100	1100 / 1200
4.22		Fork dimensions ISO 2331 ⁽⁶⁾	s/e/l (mm)	60 / 180 / 1140	60 / 180 / 1140	60 / 180 / 1140
4.23		Fork carriage ISO 2328, class/type A, B		-	-	-
4.24		Fork carriage width ⁽⁶⁾	b3 (mm)	700 / 780 / 860	700 / 780 / 860	700 / 780 / 860
4.25		Distance between fork-arms ⁽⁷⁾	b5 (mm)	520 / 560 / 680	520 / 560 / 680	520 / 560 / 680
4.27		Width across guide rolls ⁽³⁾	b6 (mm)	1075 / 1130 / 1330	1175 / 1230 / 1430	1175 / 1230 / 1430
4.31		Ground clearance, laden, below mast	m1 (mm)	60	60	60
4.32		Ground clearance, centre of wheelbase ⁽⁸⁾	m2 (mm)	60	60	60
4.33		Load dimensions b12 x l6 crossways	b12 x l6 (mm)	-	-	-
4.34.1	Aisle width for pallets 1000 x 1200 crossways	Ast (mm)	1400	1400	1400	
4.34.2	Aisle width for pallets 800 x 1200 lengthways ⁽⁹⁾	Ast (mm)	1200	1300	1400	
4.35	Turning radius	Wa (mm)	1768	1809	1905	
Performance data	5.1	Travel speed, laden/unladen ^{(4) (9)}	km/h	8.8 / 9.0	8.8 / 9	8.8 / 9
	5.2.1	Lift speed, laden/unladen (Cab) ⁽⁴⁾	km/h	0.35 / 0.42	0.31 / 0.42	0.31 / 0.42
	5.2.2	Lift speed, laden/unladen (SL) ⁽⁴⁾	m/s	0.22 / 0.24	0.2 / 0.24	0.2 / 0.24
	5.3.1	Lowering speed, laden/unladen (Cab) ⁽⁴⁾	m/s	0.37 / 0.37	0.38 / 0.38	0.38 / 0.38
	5.3.2	Lowering speed, laden/unladen (SL) ⁽⁴⁾	m/s	0.12 / 0.14	0.12 / 0.14	0.12 / 0.14
	5.7	Gradeability, laden/unladen ⁽⁸⁾	m/s	6.3	6.2	5.8
	5.10	Service brake	%	Electro Magnetic	Electro Magnetic	Electro Magnetic
Electric-engine	6.1	Drive motor rating S2 60 min		6.4	6.4	6.4
	6.2	Lift motor rating at S3 15%	kW	12	12	12
	6.3	Battery according to DIN 43531/35/36 A, B, C, no	kW	No	DIN 43531 B	DIN 43531 B
	6.4	Battery voltage/nominal capacity K5	(V) / (Ah)	48 / 310	48 / 420	48 / 560
	6.5	Battery weight	kg	549	746	937
	6.6	Energy consumption according to VDI cycle ⁽¹⁰⁾	kWh/h @ no. of cycles	3.27	3.27	3.27
8.1	Type of drive unit		AC ~ MOSFET	AC ~ MOSFET	AC ~ MOSFET	
10.7	Sound pressure level at the driver's seat ⁽¹¹⁾	dB (A)	59	59	59	

⁽⁴⁾ **All models:** See VDI table or refer to your local sales representative for Ast values not listed.

⁽⁵⁾ Values determined by wheel friction, if climbing ramps frequently (within 1h), consult your sales representative.

⁽⁶⁾ Performance Mode: 3 preset values available, selected by the operator: soft, medium, hard. All values listed are in Hard mode.

⁽⁷⁾ Value determined with highest mast, see chart for other h data.

⁽⁸⁾ With wire guidance l1 and l2 + 40mm.

⁽⁹⁾ Minimum size is shown, for other size contact the dealer.

⁽¹⁰⁾ b12: width WP; b2 is the same as non WP version.

MO10, MO10S models VDI Notes:

⁽¹⁾ With FEM carriage and forks 100 x 35 add + 25mm.

^(2a) With 3 stage mast add 55mm.

^(2b) With 2 stage mast reduce 55mm.

⁽³⁾ With Lift interrupt mounted on Overhead

Guard: h6 & h4 are increased by 105mm. With flashing light fitted on Overhead Guard: h6 & h4 are increased by 120mm.

⁽⁴⁾ With FEM carriage and forks 80 x 30 h13 = 60mm - With FEM carriage and forks 100 x 35 h13 = 65mm.

⁽⁵⁾ Available also FEM carriage and fork size 100 x 35 with 1000 Kg @ 600 mm.

⁽⁶⁾ With FEM carriage b3 = 800mm.

⁽⁷⁾ With FEM carriage and forks 100 x 35 b5 max = 773mm.

⁽⁸⁾ Sensor height 30mm from the ground.

⁽⁹⁾ Acceleration: 3 preset values (soft, medium, hard) are available, they can be selected directly by the operator.

⁽¹⁰⁾ Value found using a MO10 with 2 stage mast h12= 4000mm.

⁽¹¹⁾ Value found using a MO10 with 2 stage mast h12= 4920mm.

MO AC series

Models: MO10E AC 0.7, 15FC, 12, 12SL, 17SL, WP, 48SL, 48WP, MO10 AC, MO10S AC

Yale[®] 
People. Products. Productivity.™

Operator Compartment

The operator cab allows the operator to find the most comfortable driving position. The platform is cushioned to absorb vibrations and incorporates an operator presence switch over the entire floor surface area. The cabin bulkhead is angled and padded to facilitate access to the load support. The low step height is a further aid to driver comfort and productivity.

MO10E Fixed Cab models feature a non-raising cab and forks that can be lifted up to a height of 1500mm. The standard platform is open on two sides for direct access/pass through.

MO10E AC 12 models have a maximum cabin platform lifting height of 1200mm. The standard platform is open on three sides for direct access to the pallet/load. The forks are welded directly to the cabin floor structure.

MO10E Supplementary Lift (SL) models have a maximum cabin platform lifting height of 4800mm and feature pallet/load auxiliary lift.

MO10E Walk on Pallet (WP) models have fixed forks, welded directly to the cabin floor structure, with platform lifting heights of 4800mm. The compartment is fitted with closing side gates forming an enclosed cage around the pallet, and the cabin has its own gates for operator entry and exit. The side gates are spring assisted and the integral toe board lifts up with the side arms to maintain a low step height for on/off access. An abseil device is provided with the truck. Storage facilities are located under the control console.

Chassis

Chassis are available in different widths and are manufactured using a heavy duty welded construction, including a thick bumper plate to protect components from the effect of any impact. The short chassis head L2 enhances manoeuvring, and the narrow width facilitates two-way traffic in the aisle. An overhead guard will be supplied for h12 higher than 1200mm. MO10 model has a maximum cabin platform lifting height of 4920mm and features pallet/load auxiliary lift. MO10S models have a maximum cabin platform lifting height of 9145mm when featuring pallet/load auxiliary lift and 6920mm when featuring fixed forks welded directly to the cab (Walk on Pallet).

Controls

The controls are located to maximise the walk-through area of the platform for easy pick-face access either side of the aisle. The control console is mounted on the drive side of the truck. The butterfly switch controls travel speed and forward/reverse direction. Whilst the left mini-lever controls the main lift/lower function for efficiency, the right mini-lever acts as an emergency stop actuator.

Extensive use of CANbus enhances the performance of the truck providing a quick response to any controls activated. Wiring complexity is reduced simplifying service maintenance. Hall effect sensors have replaced mechanical micro-switches increasing reliability.

Graphic Display

The graphic display is readable under all light conditions and contains a wealth of truck status information including: steer wheel position, cabin platform height, traction and/or lifting-lowering speed, fault code display, battery discharge status and preset

performance levels which the operator can easily set dependent on the application. Additional information on technical services for example sensor tests and functions is accessible via a password. Password protection for up to 20 operators is also available as a standard option, as are selectable picking intermediate stops lift levels and adjustable height pre-selection.

Steering

The electric steering system is "fly-by-wire" technology and incorporates a high efficiency AC motor. An ergonomically designed steering wheel is adjustable for enhanced steering feedback. The self-centring steering mechanism works automatically when the truck is turned on, via a push button on the control panel or when the creep speed advance mode is activated. On entering a guided aisle the steer wheel is automatically centred and steering is disengaged.

Creep Speed Advance

The "pedestrian mode" creep speed function allows the operator to advance the truck, and lift or lower the platform (and forks on the SL model) while on the ground next to the truck.

Supplementary lift

The supplementary carriage/forks are mounted on a bulkhead fitted to the operator's compartment and provide auxiliary lift. The materials handling interface and/or load can be raised or lowered to maintain a constant comfortable working height throughout the pick routine, reducing bending and stretching for the operator. The auxiliary lift/lower control requires two-handed operation. Pallet or FEM forks are available.

Walk on Pallet cage (WP)

The walk on pallet cage model allows direct access to the pallet at heights over 1200mm. Access to the operator's compartment and the pallet is provided via spring assisted swing-up gates. The cage is a strong metal structure which surrounds the pallet and features 2 swing-up gates on each side allowing full pick access from floor level. An additional retention rail is fitted at the load end of the cage. A fork-mounted pallet sensor prevents traction/lifting above 1200mm raised platform height with empty forks. The side and cabin gates are interlocked and must be deployed above this height for traction.

Mast

The mast section design provides torsional rigidity and minimises deflection.

The panorama design provides excellent visibility of the working environment. Slack chain detection devices mounted on the mast prevent further lowering if an obstacle is encountered. Lowering speed is automatically reduced as the cab nears the floor. The MO10/MO10S feature two stage mast options, with a three stage mast option available on the MO10S with a maximum cabin lifting height of up to 9145mm (depending on model - see VDI & mast tables). A strobe light is mounted on the chassis behind the mast.

The MO10E offers one stage mast with a lifting height (h12) up to 1860mm and two stage masts up to 4800mm with a proven mast profile.

Traction - Steering Unit

A powerful AC traction motor, with instant response to forward and reverse traction inputs, provides

considerable torque, delivers fast acceleration and travel speeds matched to the model specification, with almost no difference in unladen and laden performance. The fixed motor and vertically mounted drive unit eliminate flexing stresses to the power cables to ensure maximum uptime.

The electronic AC+DC combi MOSFET (MO10E) & AC (MO10-10S) controllers manage traction and hoist, offering excellent management of power and consumption, acceleration and regenerative braking.

The performance parameters can be adjusted using an external handset. Self diagnostics and thermal protection are features of the controller. The maintenance free motor (inspection intervals every 1000 operating hours) provides low cost long operational life.

Hydraulic system

The DC (MO10E) or AC (MO10-10S) pump motor guarantees consistent performance matched to the model specification. The MOSFET control provides proportional handling for lifting through control of the motor as well as proportional control on lowering movements of the cab and supplementary lift. The pump motor regenerative action (MO10-10S) provides efficient energy management, smooth starting and stopping.

Hose break valves prevent lowering in the event of a line break and a manual lowering valve allows emergency cab lowering to the ground. The integral and transparent plastic hydraulic tank allows easy checking of the oil level.

Brakes

The drive motor brakes automatically when the butterfly control is released. An electromagnetic parking brake is activated by a platform sensor. Emergency braking is carried out with a fingertip control and activates powerful reverse direction braking and the electromagnetic brake. If the operator leaves the platform, the emergency brake activates immediately.

Batteries

MO10E - 24V; 500 to 620 Ah

MO10 - 48V; 280 to 310 Ah

MO10S - 48V; 420 to 620 Ah

A flip up cover provides easy access for battery servicing and checking. The battery is mounted on rollers to facilitate left side extraction with a roller bed trolley available as an option to facilitate double shift operation.

Guidance Options

MO10 range trucks may be free ranging or fitted with guidance options. Guided trucks can increase productivity as maximum speed can be maintained to higher heights inside the working aisle as the driver can simultaneously travel and lift or lower without having to focus on steering. Guidance options include wire-guidance package or rollers for rail guidance. The on-board wire guidance package includes sensors mounted fore and aft as well as a truck logic module linked to the steering system. The standard operating frequency is 6.25 kHz.

Optional Extras

A wide range of options is available. Further information on these is available from your local Yale dealer.

NACCO Materials Handling Limited
trading as **Yale Europe Materials Handling**

Flagship House, Reading Road North,
Fleet, Hampshire GU51 4WD, United Kingdom.

Tel: + 44 (0) 1252 770700 Fax: + 44 (0) 1252 770784

www.yale-forklifts.eu

Country of Registration: England. Company Registration Number: 02636775



Safety. This truck conforms to the current EU requirements. Specification is subject to change without notice.

Yale, VERACITOR and  are registered trademarks. "PEOPLE, PRODUCTS, PRODUCTIVITY", PREMIER, Hi-Vis, and CSS are trademarks in the United States and certain other jurisdictions. MATERIALS HANDLING CENTRAL and MATERIAL HANDLING CENTRAL are Service Marks in the United States and certain other jurisdictions.

 is a Registered Copyright. © Yale Europe Materials Handling 2013. All rights reserved.

Truck shown with optional equipment

Printed in The United Kingdom (0313HG) EN

Publication part no. 258985565 Rev.05